

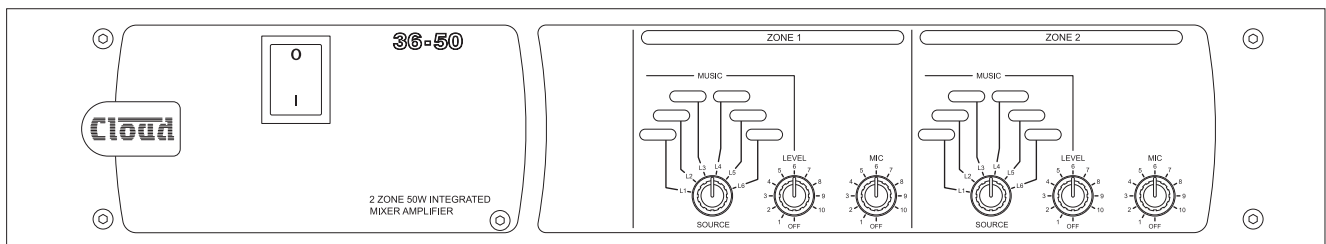

36-50 MULTI-ZONE MIXING AMPLIFIER





Installation and User Guide

WARNING:

To reduce the risk of fire or electric shock, do not expose this appliance to rain or moisture.

CAUTION:

Use of controls or adjustments or performance of procedures other than those specified may result in hazardous radiation exposure.

	<p>WARNING: SHOCK HAZARD – DO NOT OPEN AVIS: RISQUE DE CHOC ELECTRIQUE – NE PAS OUVRIR</p>
	<p>The lightning flash with the arrowhead symbol within an equilateral triangle, is intended to alert you to the presence of uninsulated dangerous voltages within the product's enclosure that may be of sufficient magnitude to constitute a risk of electric shock.</p>
	<p>The exclamation point within an equilateral triangle is intended to alert the user to the presence of important operating and maintenance (servicing) instructions in the literature accompanying the appliance.</p>

IMPORTANT SAFETY INSTRUCTIONS

1. Read these Instructions.
2. Keep these Instructions.
3. Heed all Warnings.
4. Follow all Instructions.
5. Do not use this apparatus near water.
6. Clean only with a dry cloth.
7. Do not block any ventilation openings. Install in accordance with the manufacturers' instructions.
8. Do not install near any heat sources such as radiators, heat registers, stoves or other apparatus (including amplifiers) that produce heat.
9. Do not defeat the safety purpose of the polarized or grounding - type plug. A polarized plug has two blades with one wider than the other. A grounding type plug has two blades and a third grounding prong. The wide blade or the third prong are provided for your safety. When the provided plug does not fit into your outlet, consult an electrician for replacement of the obsolete outlet.
10. Protect the power cord from being walked on or pinched particularly at plugs, convenience receptacles, and the point where they exit from the apparatus.
11. Only use attachments/accessories specified by the manufacturer.
12.  Use only with the cart, stand, tripod, bracket or table specified by the manufacturer or sold with the apparatus, when a cart is used, use caution when moving the cart/apparatus combination to avoid injury from tip-over.
13. Unplug this apparatus during lightning storms or when unused for long periods of time.
14. Refer all servicing to qualified service personnel. Servicing is required when the apparatus has been damaged in any way, such as power-supply cord or plug is damaged, liquid has been spilled or objects have fallen into the apparatus, the apparatus has been exposed to rain or moisture, does not operate normally, or has been dropped.



Do not expose the apparatus to dripping or splashing, and ensure that no objects filled with water, such as vases, are placed on the apparatus.

L'appareil ne doit être exposé aux écoulements ou aux éclaboussures et aucun objet ne contenant de liquide, tel qu'un vase, ne doit être placé sur l'appareil.



The mains plug is used as the disconnect device and it should remain readily accessible during intended use. In order to isolate the apparatus from the mains, the mains plug should be completely removed from the mains outlet socket.

Le prise du secteur ne doit pas être obstruée ou doit être facilement accessible pendant son utilisation. Pour être complètement déconnecté de l'alimentation d'entrée, la prise doit être débranchée du secteur.



This apparatus is of Class I construction and must only be connected to a mains outlet socket with a protective earthing connection.



Terminals marked with the ⚡ symbol may use Class 2 Wiring, but voltages at these terminals may be of sufficient magnitude to constitute a risk of electric shock. The external wiring connected to these terminals requires installation by an instructed person or the use of pre-made leads or cords.

Contents

IMPORTANT SAFETY INSTRUCTIONS	3
SAFETY INFORMATION	6
Safety Notes regarding Installation	6
Conformities.....	6
Safety Considerations and Information	6
Caution – High Voltage.....	6
Caution – Mains Fuse	6
Caution – Servicing.....	6
OVERVIEW	7
Introduction	7
Scope of this manual	7
What’s in the box	7
36-50 Main features.....	7
Optional system components.....	8
RL-I Series Remote Music Level Control.....	8
RSL-6 Series Remote Music Level/Source Control	8
PM Series microphones.....	8
Block Diagram	9
Front panel description	10
Rear panel description	11
INSTALLATION.....	12
Hardware considerations.....	12
Power Supply	12
Fuses and ratings.....	12
System connections.....	12
Music sources	12
Microphone input	13
Paging system connections	13
Music control.....	14
Music Mute.....	15
Speaker outputs (Lo-Z).....	15
Speaker outputs (100/70V-line operation)	15

SETTING UP & OPERATION.....	16
Music Inputs	16
Gain & level.....	16
Local/remote control.....	16
Microphone input	17
Phantom power	17
Gain & level.....	17
EQ	17
High-pass filter	17
Zone and Utility outputs.....	17
EQ	17
Utility output settings.....	17
High-pass filters	17
Priorities	18
Mic-over-Music priority.....	18
Line 6 priority.....	18
OPTIONS AND ADDITIONAL INFORMATION.....	19
RL-1 and RSL-6 Series remote control plates – general considerations	19
Control of music source and level via external DC	19
Fitting loudspeaker EQ cards	20
Fitting the CXL-3120 transformer module	20
APPENDIX	21
Table of internal jumpers and default settings.....	21
PCB jumper locations.....	22
EMC considerations	22
Ground loops	22
TECHNICAL SPECIFICATIONS	23
GENERAL SPECIFICATIONS.....	23

SAFETY INFORMATION

Safety Notes regarding Installation

- Do not expose the unit to water or moisture.
- Do not expose the unit to naked flames.
- Do not block or restrict any air vent.
- Do not operate the unit in ambient temperatures above 35°C
- Do not touch any part or terminal carrying the hazardous live symbol ⚡ while power is supplied to the unit.
- Do not perform any internal adjustments unless you are qualified to do so and fully understand the hazards associated with mains-operated equipment.
- The unit has no user-serviceable parts. Refer servicing to qualified service personnel.
- If the moulded plug is cut off the AC power lead for any reason, the discarded plug is a potential hazard and should be disposed of in a responsible manner.

Conformities

This product conforms to the following European EMC Standards:

BS EN 55103-1:2009

BS EN 55103-2:2009



This product has been tested for use in commercial and light industrial environments. If the unit is used in controlled EMC environments, the urban outdoors, heavy industrial environments or close to railways, transmitters, overhead power lines, etc., the performance of the unit may be degraded.

The product conforms to the following European electrical safety standard:

BS EN 60065:2012

Safety Considerations and Information

The Cloud 36-50 must be earthed. Ensure that the mains power supply provides an effective earth connection using a three-wire termination.

Caution – High Voltage

Do not touch any part or terminal carrying the hazardous live symbol ⚡ while power is applied to the unit. Terminals to which the hazardous live symbol refers require installation by a qualified person.

Caution – Mains Fuse

The 36-50 contains no user-replaceable fuses. Mains over-current protection is provided by the fuse in the IEC receptacle; only replace this fuse with one of an identical type and rating. If the replacement fuse blows immediately it indicates that the mixing amplifier has developed a fault, which should be referred to competent service personnel.

Caution – Servicing

The unit contains no user-serviceable parts. Refer servicing to qualified personnel. Do not perform servicing unless you are qualified to do so. Disconnect the power cable from the unit before removing the top panel and do not make any internal adjustments with the unit switched on. Only reassemble the unit using bolts/screws identical to the original parts.

OVERVIEW

Introduction

Thank you for purchasing this Cloud Multi-Zone Mixing Amplifier. We are confident that you will be pleased with its performance, features, flexibility and reliability.

The Cloud 36-50 is a three-zone (two primary zones plus a Utility output), analogue audio mixing amplifier. It combines simple control of background music with versatile microphone paging and power amplification in a single unit. It is suitable for use in many types of premises, including pubs, bars, clubs, shops, offices, hotels, etc. It is compatible with Cloud PM Series paging microphones and is also designed to interface with most third-party paging microphones conforming to industry standards.

Scope of this manual

This manual provides a comprehensive guide to the features and functionality of the Cloud 36-50 Multi-Zone Mixer Amplifier. The 36-50 is available in two versions, the 36-50 and 36-50T. The two models are identical in facilities and features, and differ only in that the 36-50T includes a factory-fitted and pre-wired CXL-3120 transformer module for 70 V-line operation (can be altered to 100 V-line operation).

Please read through the manual to become fully acquainted with the various configuration and control functions the 36-50 offers.

The manual is arranged as follows:

- **Overview** – introduction to the 36-50 and its options.
- **Installation** – wiring the 36-50 in a practical situation.
- **Setting Up & Operation** – setting the system up and user instructions.
- **Options and Additional Information** – additional information about system options.
- **Appendix** – additional technical information. Includes technical specifications.

The 36-50 manual includes basic information on interfacing Cloud PM Series paging microphones and connecting Cloud RL-I Series and RSL-6 Series remote control plates. Full installation information for each of these options is supplied with the items themselves.

Thank you again for placing your confidence in Cloud products.

What's in the box

Unpack the 36-50 and its accessories with care. It is always a good idea to store all packaging (if practical), in case you ever need to return the unit to your Cloud dealer for any reason.

As well as this manual, the shipping carton should contain the items listed below. Please contact your Cloud dealer immediately if any of them are missing or damaged.

- Cloud 36-50 (or 36-50T) Multi-Zone Mixing Amplifier
- IEC mains lead (AC cord) with moulded plug appropriate to the territory
- Set of mating connectors for all rear panel multi-pin screw-terminal connectors
- Set of rubber feet, with fixing screws
- Miniature multi-blade adjustment tool

36-50 Main features

- Mixing Amplifier for two or three zones (Zone 3 via Utility output)
- Utility output can be used for a third zone, secondary areas, or can double power output available for Zone 1
- Six (unbalanced) stereo line inputs with individual gain trim controls
- Front panel user controls for music source, music level and mic level in each zone
- Balanced mic input; 15 V phantom power selectable
- Contact closure access port for paging zone selection
- Switchable mic-over-music priority (Automatic Voice Over)
- Selectable LINE 6 priority per-zone, with choice of release times
- 3 x 50 W power output (lo-Z operation)
- Rear panel adjustments for: i) mic input sensitivity and HF/LF EQ, ii) zone output HF/LF music EQ, iii) utility output music and mic level
- Optional internal CXL-3120 3-channel 70/100 V transformer module can be retrofitted to convert 36-50 to 36-50T
- Optional external CXL-40T 70/100 V toroidal transformers available for use with any or all outputs
- Selectable 65 Hz high-pass filter per-output (for use with 70/100 V transformers)
- Music Mute control input (N/O or N/C) to interface to emergency system
- Compatible with standard Cloud remote control plates: RL Series (music level) and RSL Series (music level and source selection), per-zone
- Optional EQ cards available to suit various popular installation loudspeakers may be fitted to any or all outputs
- 2U 19" rack-mounting unit
- Convection cooled – silent in operation

Optional system components

The following components may form part of the audio system and may be ordered separately if required. They may also be retrofitted to a system at a later time. Separate datasheets are available for each of the individual components; download them at www.cloud.co.uk.

RL-1 Series Remote Music Level Control

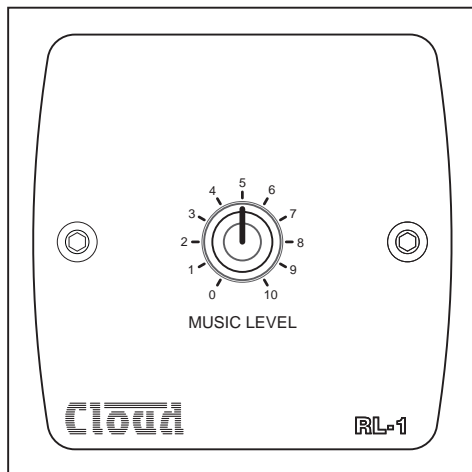

The RL-1 Series is a range of small plates with a single control for locally adjusting the music level in a zone. They connect to one of the 36-50's REMOTE SOURCE + LEVEL ports. See page 14 and page 19 for more information.

RSL-6 Series Remote Music Level/ Source Control

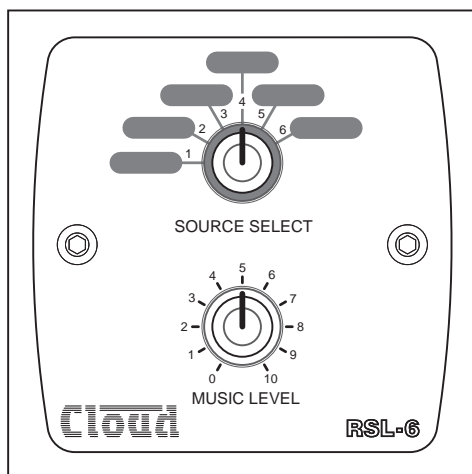

The RSL-6 Series is a range of plates allowing local (per-zone) music source selection as well as music level control. They are the same size as the RL-1s, and connect in a similar way. See page 15 and page 19 for more information.

PM Series microphones

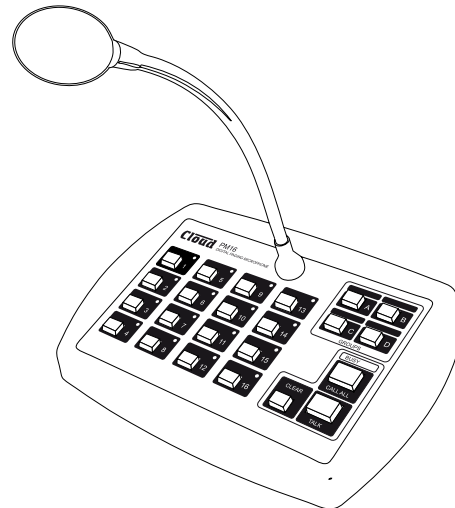

Cloud PM Series paging microphones may be connected directly to the 36-50 using the mic input and access port. Models are available which can page to 4, 8, 12 or 16 zones, and also to 4 or 8 zones with storage for built-in spot announcements. As the 36-50 only supports three zones, not all zones on any of the models can be accommodated by a single 36-50; the PM4 and PM4-SA (4-zone) models are most likely to be useful. See page 13 for more information.

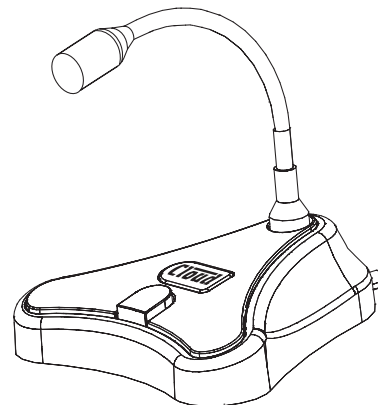

The Cloud PMI paging microphone is also compatible with the 36-50. It is a much simpler unit which addresses a single zone (though zones may be paralleled for wider access). See page 14 for more information.

Block Diagram

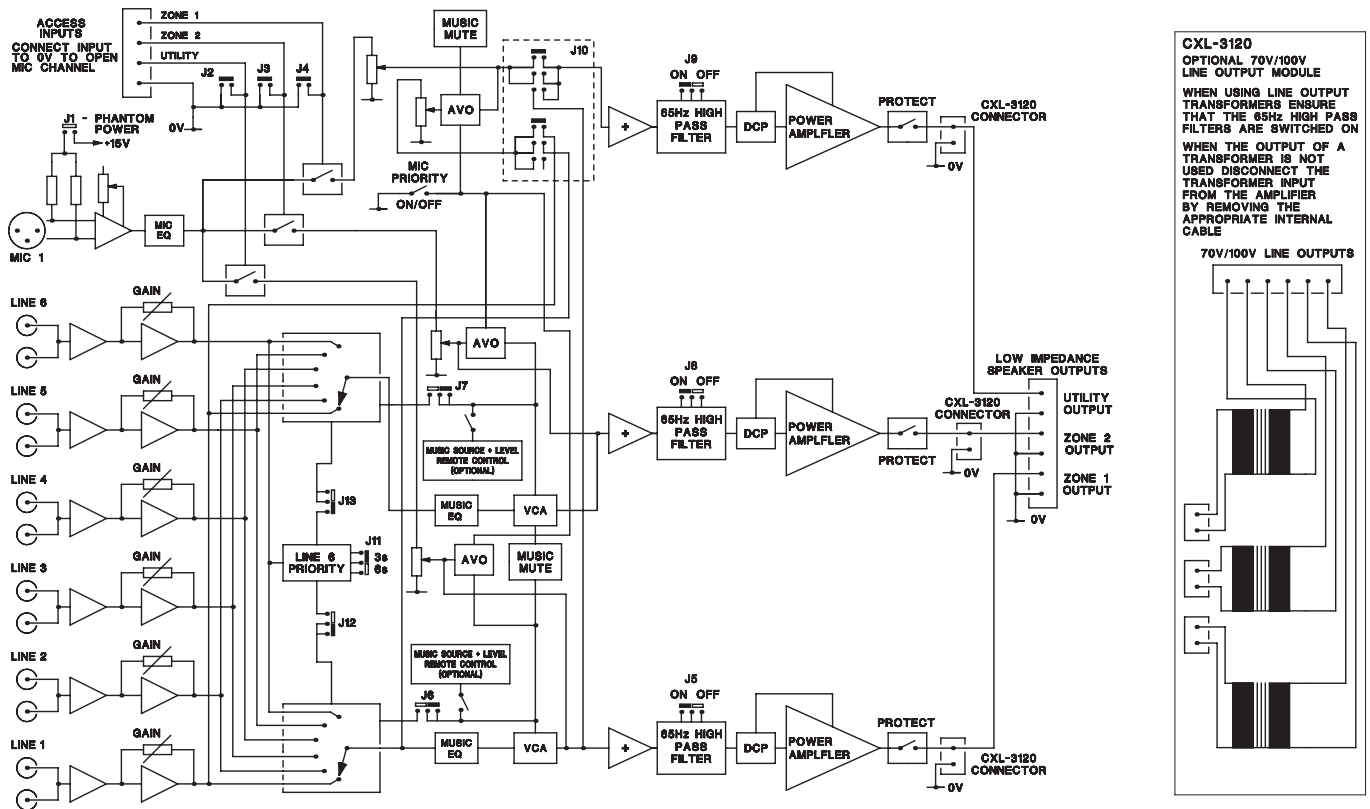

The simplified block diagram above illustrates the basic signal architecture of the 36-50.

Front panel description

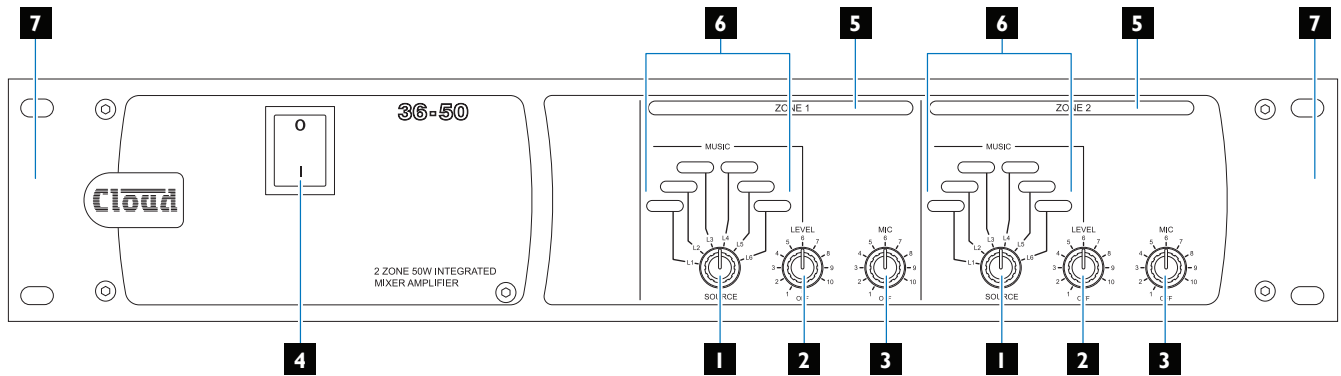

1. **MUSIC SOURCE** – 6-way rotary switch selecting which Line Input (1 to 6) will be the music source for each zone. See page 16.
2. **MUSIC LEVEL** – adjusts the music level in each zone. See page 16.
3. **MIC** – adjusts the level of the microphone connected to the rear panel mic input in each zone. See page 16.
4. **Power** – rocker switch with internal illumination.
5. **Zone idents** – a space is provided above each zone's controls for printed labels identifying the zone by name.
6. **Source idents** – a space is provided above the **MUSIC SOURCE** controls for printed labels identifying each music source by name.
7. **Rack mounting ears** - the unit may be rack-mounted in a standard 19" equipment rack. It requires 2U of rack height. See page 12.

Rear panel description

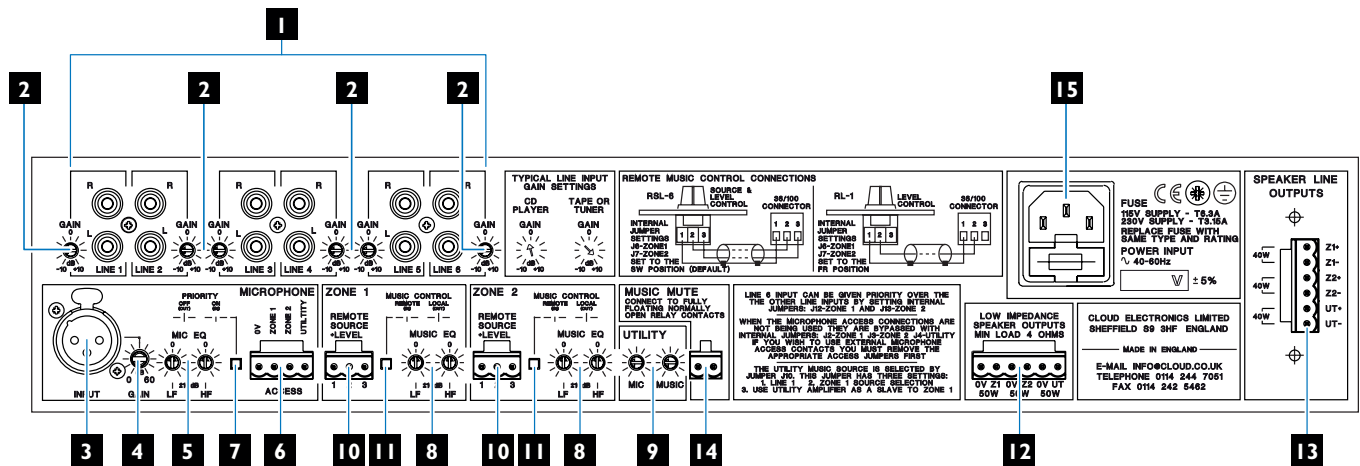

1. **LINE 1 to LINE 6** – 6 pairs of RCA (phono) sockets for connection of utility music sources. Inputs are stereo, summed internally to mono. See page 12.
2. **GAIN** – preset trim control for each line input, providing ± 10 dB of gain adjustment for input level matching. See page 16.
3. **MICROPHONE INPUT** – balanced microphone input on 3-pin female XLR connector. See page 13.
4. **GAIN** – preset mic gain control, gain range 10 to 60 dB. See page 16.
5. **MIC EQ** – HF & LF preset EQ controls. See page 17.
6. **ACCESS** – 4-pin 5 mm-pitch screw-terminal connector for per-zone paging access by contact closure. See page 13.
7. **PRIORITY** – activates Automatic Voice Over (AVO) mode, giving immediate priority to announcements made via the mic input. See page 18.
8. **MUSIC EQ** – HF & LF EQ adjustment for each zone output. See page 17.
9. **UTILITY MIC & MUSIC** – two pre-set controls, adjusting the level of the microphone input and chosen music source respectively at the Utility Output. See page 17.
10. **REMOTE SOURCE + LEVEL** – 3-pin 5 mm-pitch screw terminal connector for each primary zone, for connection of RL-1/RSL-6 remote control plates. See page 14.
11. **MUSIC CONTROL SWITCHES** – determine whether front panel music source and level controls will remain active when remote control plates are connected (per-zone). See page 14.
12. **LOW IMPEDANCE SPEAKER OUTPUTS** – outputs for each of the three zones (two primary plus Utility output) on 3-pin 3.5 mm-pitch screw-terminal connector. See page 15
13. **SPEAKER LINE OUTPUTS** – location of output terminals for 70 V/100 V-line operation when CXL-3120 transformer module is fitted internally (either on Model 36-50T, or as retrofitted option). See page 15.
14. **MUSIC MUTE** – 2-pin 5 mm-pitch screw terminal connector for connection of external emergency muting relay (e.g. fire control panel). See page 15.
15. **Mains** – fused IEC receptacle for AC mains (includes storage for spare fuse). See page 12.

INSTALLATION

Hardware considerations

The 36-50 Mixing Amplifier is built in a 2U-high 19" rack mount enclosure. It is recommended that the 36-50 is installed in a 19" rack wherever possible. The units are approx. 300 mm deep, but at least 400 mm of rack depth should be available to allow for rear connectors and cabling.

The 36-50 uses convection cooling and there are no thermal considerations other than ensuring that the ventilation grilles are not obstructed once the Mixing Amplifier is installed. The ventilation grilles are in the top and bottom panels, to the right-hand side of the panels as viewed from the front. It is recommended that 1U ventilation panels are fitted in the rack above and below the 36-50.

If the unit is to be used free-standing (i.e., not mounted in a rack), the four feet supplied in the accessory pack should be fitted to the bottom of the unit to provide a satisfactory airflow. Attach these with the M4 x 12 pan-head screws provided; four M4 tapped holes are clearly identifiable in the corners of the bottom panel.



Do not use any longer screws, as they may foul internal components or wiring.

The choice of location will be dictated by the specifics of the system and building layout. It is recommended that wherever possible, the 36-50 should be mounted adjacent to as many of the music sources (CD players, music servers, TV receiver boxes, etc.) as practical.

When deciding the Mixing Amplifier's location, bear in mind that access to it (particularly the rear panel) will probably be required even if a full complement of remote controls is being fitted as part of the system, as certain adjustments can only be made on the unit itself.

Power Supply

The European version of the 36-50 operates on standard 230V AC mains; an alternative version is available which operates on 115V AC. An IEC mains cable with a plug appropriate for each country is supplied with the European unit. The unit's power consumption is 112VA (measured using pink noise, all channels driven at 1/3-rated max. power into 4 ohms.)

Fuses and ratings

The only externally-accessible fuse is an AC mains fuse in the IEC connector housing. Only replace a fuse with one of exactly the same type. The table below gives the correct fuse types.

VERSION	RATING	FUSE TYPE
230V	3.15 A	20 mm x 5 mm slo-blo T3.15AH
115V	6.3 A	20 mm x 5 mm slo-blo T6.3AH

The fuseholder may be accessed by prising the slide below the connector open, using a small screwdriver. The holder has an extra cavity for storing a spare fuse; note that the "active" fuse

is that in the inner cavity.

Internally, two 20mm x 5mm fast-blow F4.0A fuses protect each amplifier channel (six in total). These are service components, and should not require attention. Failure of any of these fuses indicates a fault condition, which should be immediately referred to a competent technician or authorised service centre.

System connections

Music sources

Connect the system's various music sources to **LINE 1** to **LINE 6**. All line inputs offer unbalanced connection for stereo sources on a pair of standard RCA jacks (phono sockets). The sensitivity range available should allow most standard items of audio equipment such as computers/tablets, music servers and media receivers, etc., to operate at a satisfactory level. Most equipment of this type will have stereo unbalanced outputs, and as long as the source equipment is adjacent to the Mixing Amplifier, normal phono-phono (or 3.5 mm jack-to-phono) leads can be used. Always avoid using pre-made leads of an unnecessary length.

Mono and stereo sources:

The mixing section of the 36-50 is mono; the stereo line inputs are summed internally. Stereo sources should be connected in a normal stereo configuration, using both L and R inputs. If connecting a mono source with only a single output, it may be connected to either the left or the right input.

Balanced sources:

If it is necessary to connect an item of source equipment with a balanced output to the 36-50, a balancing transformer should ideally be inserted between the source and the unbalanced input. Suitable audio transformers, which should have a ratio of 1:1, are readily available from major audio component suppliers. The transformer(s) should be mounted as close to the 36-50 as practical, and housed in a screened enclosure if they are not individually screened. The preferred connection method is shown below.

Balanced outputs (XLRs):

pin 1 ground
pin 2 hot
pin 3 cold

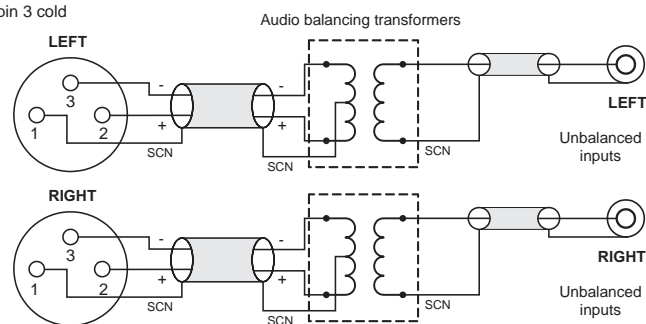

If transformers are not available, a balanced source may feed an unbalanced input directly as long as care is taken over how

the connections are made. A variety of design techniques are in use to implement balanced outputs in audio equipment, and some designs require different wiring protocols to others. Installers are advised to check the manuals with each item for guidance on how the outputs should be connected to an unbalanced input.

However, the wiring methods shown below will work in a large number of cases. If hum or other distortion is found to result, try disconnecting the 'cold' leg of the balanced output (pin 3 on XLRs).

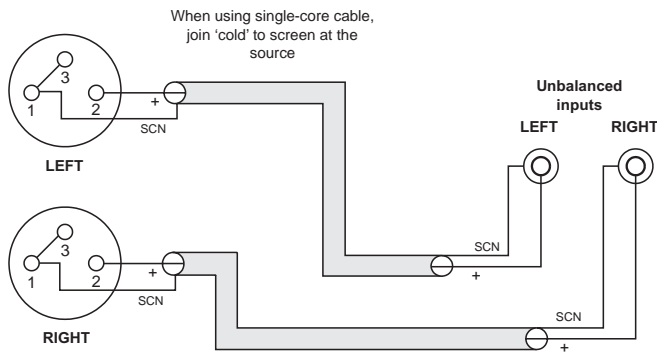

Balanced outputs (XLRs):
pin 1 ground
pin 2 hot
pin 3 cold

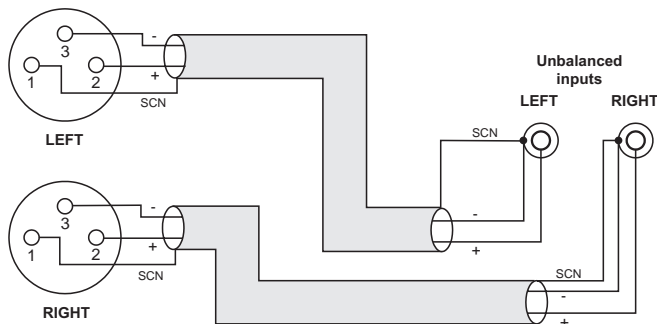

Balanced outputs (XLRs):
pin 1 ground
pin 2 hot
pin 3 cold

When using twin-and-screen cable, join 'cold' to screen at 36-50 end

Microphone input

The **MICROPHONE INPUT** is intended for the direct connection of microphones. It is electronically balanced and transformerless with an input impedance of greater than 2 kohms and optimised for use with microphones of 200 to 600 ohms impedance. The XLR input connector should be wired thus:

PIN	CONNECTION
1	Screen
2	Signal '+' (hot)
3	Signal '-' (cold)

Unbalanced microphones may be used by connecting pin 3 to pin 1 (cable screen) in the mating (male) connector. 15 V phantom power is available, see page 17.

The mic input may be routed to either primary zone, or to the Utility Output, at any level in each. Microphone priority may be set so that any microphone announcements automatically reduce the music level in that zone while the announcement is in progress (see page 18 for more details.)

Paging system connections

Cloud PM Series paging microphones may be connected directly to the 36-50.

Two connections are required: the paging mic audio signal should be connected to the **MICROPHONE INPUT** ([3] on page 11) and the control cable to the 4-pin Zone Access port ([6] on page 11). The pinout of the Zone Access port is given below:

PIN NO.	FUNCTION
1	0V
2	Zone 1
3	Zone 2
4	Utility Output

Connecting PM4/PM4-SA paging microphones

These microphones are equipped with both digital and analogue paging interfaces; with the 36-50, the analogue interface is used. PM microphones are available in 4, 8, 12 or 16-zone versions; the installer should be sure he/she understands how paging zones correspond to mixer zones before commencing wiring. Although the 36-50 only supports a maximum of three zones, there is no technical reason to prevent a PM microphone being used in a restricted manner.

Standard two-core screened audio cable may be used for the audio signal, and stranded multicore (3-core is adequate) cable with an overall screen for the control cable. Note that PM Series microphones cannot be powered from the 36-50, and need an external PSU.

Connections on the PM microphone are made via the rear cable access glands and screw terminal blocks on the internal PCB (TERM2 and TERM 8 in the case of a PM4). Full connection details can be found in the PM Series Installation and User Guide.

The following diagram shows the cable connections between a PM4 and a 36-50. Note that PM microphone must be powered independently (either by a local PSU or via the CDPM digital network from another PM unit); the 36-50 does not have a facility for providing power to external accessories.

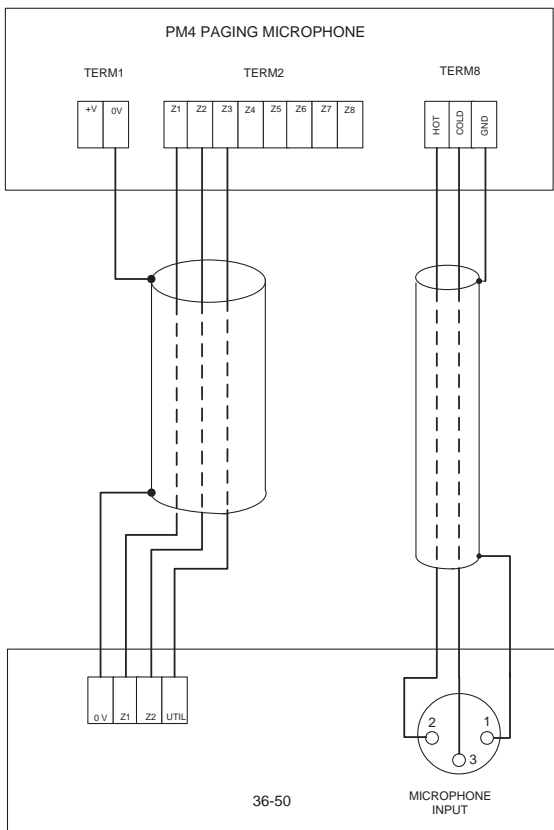

Note that the default factory setting is for all three **ACCESS** port inputs to be permanently enabled. In order for the 36-50's mic input to function correctly with a paging mic, internal jumpers J2 (Zone 1), J3 (Zone 2) and Z4 (Utility output) should be removed. See page 4 for jumper locations.

For automatic music ducking during an announcement, set the rear panel **PRIORITY** switch to ON. See page 18 for further information.

Connecting a PMI paging mic

The PM 1 is a simple, passive paging microphone suitable for situations where announcements are always made to the same zone(s). It can be connected directly to the 36-50 Mixing Amplifier, the control cable being wired to the pin(s) of the Zone Access port corresponding to the zone(s) in which announcements are required. Any or all of the zones may be paralleled if multiple zones need to operate from the PMI.

Either a single 2-pair individually-screened cable may be used (this gives the neatest finish), or two separate standard microphone cables. Connections on the PMI are made via the rear cable gland in the base and the screw terminal blocks on the internal PCB (U2 and U3). Full connection details can be found in the PMI Installation and User Guide. Note that the PMI does not require DC power.

The following diagram shows the connections between a PMI and a 36-50. Use of 2-pair cable is assumed; the same wiring principle is adopted if separate cables are being used for audio and control.

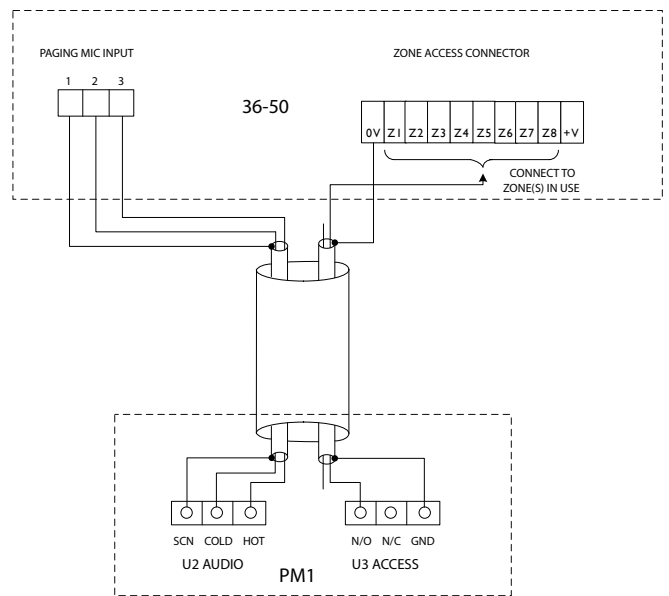

Note that the default factory setting is for all three **ACCESS** port inputs to be permanently enabled. In order for the 36-50's mic input to function correctly with a paging mic, internal jumpers J2 (Zone 1), J3 (Zone 2) and Z4 (Utility output) should be removed. See page 4 for jumper locations.

For automatic music ducking during an announcement, set the rear panel **PRIORITY** switch to ON. See page 18 for further information.

Music control

Like many other Cloud products, the 36-50 allows remote control of music level and source selection in each of the primary zones. Cloud remote control plates from the RL-1 Series (music level only) and RSL-6 Series (music level and source selection) provide an elegant solution, though control via a DC voltage from third-party systems is also possible (see page 19).

Both types of plate connect via the REMOTE SOURCE & LEVEL port for the relevant zone (see [10] on page 11). This connector is a 3-pin 5 mm-pitch screw terminal type. Please refer to page 19 for additional information regarding cable lengths, etc.

Connecting an RL-1 Series remote control plate

Wire the remote control plate as shown below. Either single-core screened or twin-and-screen cable may be used; in the case of the latter, ignore one of the cores. Maximum reliable cable run is 100 m.

REMOTE LEVEL CONTROL WIRING

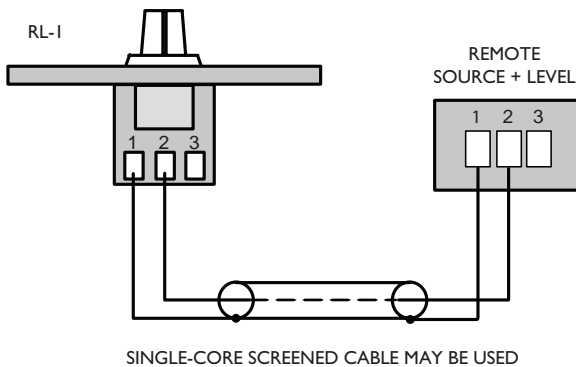

SINGLE-CORE SCREENED CABLE MAY BE USED

Before the RL-1 will operate, the zone's Music Control Port must be enabled by setting the adjacent push-button switch ([11] on page 11) to REMOTE (i.e., pressing it in). In this setting, the zone's front panel **MUSIC LEVEL** and **SOURCE SELECT** controls become inoperative. As music source selection will still be required from the mixer's front panel when an RL-1 is in use, the REMOTE setting may be overridden *for the source selection control only* by moving internal jumper J6 (Zone 1) or J7 (Zone 2) on the internal PCB. See page 4 for location of internal jumpers.

Connecting an RSL-6 Series remote control plate

Wire the remote control plate as shown below. Twin-and-screen cable should be used. Maximum reliable cable run is 100 m.

REMOTE SOURCE & LEVEL CONTROL WIRING

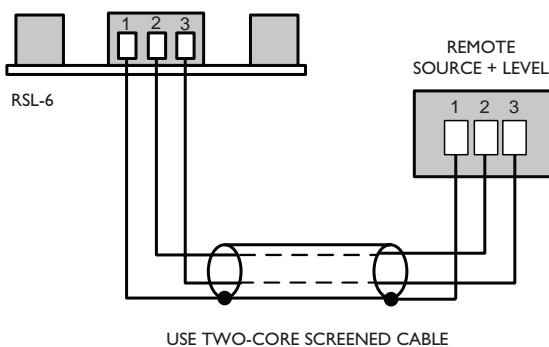

USE TWO-CORE SCREENED CABLE

Before the RSL-6 will operate, the zone's **MUSIC CONTROL** port must be enabled by setting the adjacent push-button switch ([11] on page 11) to REMOTE (i.e., pressing it in). In this setting, the zone's front panel **MUSIC LEVEL** and **SOURCE SELECT** controls become inoperative.

Music Mute

External muting of music is available at the **MUSIC MUTE** connector. National or Local Authority regulations governing such systems may require that normal programme material

(i.e., music) should be muted in an emergency, to ensure that any emergency messages are clearly audible.

The **MUSIC MUTE** input is on a 2-pin 5 mm-pitch screw-terminal connector. It should be connected to the appropriate alarm output on whichever building management system registers the alarm (typically the Fire System). The alarm output must be volt-free; if no such output is available, an intermediate relay or other isolation device must be installed between the alarm output and the **MUSIC MUTE** input.

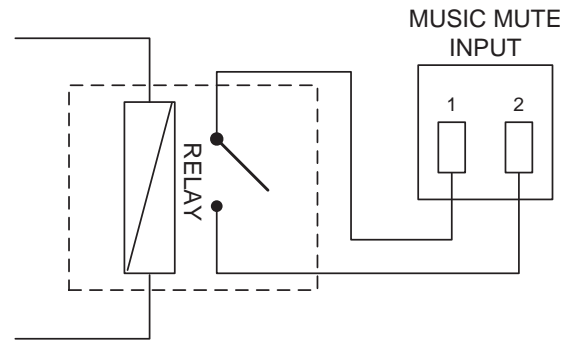

NORMALLY OPEN (NO)
CONNECTION

Speaker outputs (Lo-Z)

The speaker output connector is a 6-pin, 5 mm-pitch screw-terminal connector. Mating connectors are supplied. The power amplifier outputs of both primary zones and the Utility Output are present on this connector. Connect to speakers using pairs of terminals as shown in the table:

	Panel marking	Connect to:
1	0V	Zone 1 output '-'
2	Z1	Zone 1 output '+'
3	0V	Zone 2 output '-'
4	Z2	Zone 2 output '+'
5	0V	Utility Output
6	UT	Utility Output

Each output stage is designed to drive into an impedance of not less than 4 ohms. Check the impedance of the loudspeaker(s) in use and, taking into account any series and/or parallel wiring, ensure that the total load on each channel is not less than 4 ohms.

Speaker outputs (100/70 V-line operation)

The 36-50 may be converted for 100 V/70 V-line operation by the use of the Cloud CXL-3120 transformer module. This module is fitted internally, and consists of three independent transformers with separate flying leads, so any or all outputs of the 36-50 may be converted to 100 V and/or 70 V-line operation as required.



The low impedance outputs are still active, but should not have a load connected to them while the 70V/100V-line outputs are in use.

In the 36-50T model variant, the CXL-3120 is pre-installed at the factory, and wired for 70 V-line operation. This can be changed to 100 V-line operation (per-output) if wished by moving on-board links. Alternatively, the standard 36-50 model may be modified for 100 V/70 V-line operation by retrofitting the CXL-3120 module, which is available from Cloud Electronics as an option. Full installation instructions are supplied with the module.

When the CXL-3120 is fitted, a 6-pin 5 mm-pitch screw-terminal connector occupies the blank connector slot [13] at page 11. The connector is wired as shown below:

	Panel marking	Connect to:
1	Z1+	Zone 1 output '+'
2	Z1-	Zone 1 output '-'
3	Z2+	Zone 2 output '+'
4	Z2-	Zone 2 output '-'
5	UT+	Utility Output '+'
6	UT-	Utility Output '-'

If preferred, individual external transformers may be employed to convert low impedance outputs to 100 V/70 V-line operation. A suitable transformer is the CXL-40T, available as an accessory from Cloud Electronics. A 19" rack tray for mounting multiples of these is also available.

When using the 36-50 for 100 V/70 V-line operation, the 65 Hz high-pass filters in each zone to be used in this mode should be enabled. See page 17 for full details.

SETTING UP & OPERATION

Music Inputs

Gain & level

To avoid dramatic changes in volume when switching between sources, the 36-50's music inputs are provided with preset gain trim controls ([2] on page 11). These vary the input sensitivity from -12 dBu (195 mV) to +8 dBu (2.0 V). When setting the system up, play audio from all the sources in use and listen to them one at a time in a convenient zone (ideally that in which the mixer is located) at a reasonable volume. Taking a source of "average" volume as the reference, the gain controls of the others should be adjusted so that there is no appreciable difference in volume between any of the sources. (With a typical music source, setting the gain on its channel to mid-way is a good starting point.) Note that consideration may need to be given to the type of programme in use, particularly if one or more sources are TV sound.

In normal operation, the music level in each primary zone is set with the **MUSIC LEVEL** control on the front panel ([2] on page 10). This control will not be operative if the corresponding rear panel **MUSIC CONTROL** push-button is set to REMOTE. The music level at the Utility output is set with the rear panel preset control ([9] on page 11).

Note that the setting of the music level has no effect on microphone volume.

Local/remote control

If a zone has an RL-1 or RSL-6 Series remote control plate connected in any zone(s), the corresponding rear panel **MUSIC CONTROL** push-button(s) must be set to REMOTE (button in) for the remote controls to be operative and for the corresponding front panel controls to be disabled. Zones without such plates should be set to LOCAL (button out).

The setting of the internal PCB jumpers J6 and J7 is also relevant. The default setting is SW. This means that the method of zone music source selection will be determined by the rear panel switch setting; the front panel control will make the selection if **MUSIC CONTROL** is set to LOCAL and via a remote plate or other external control if set to REMOTE. If a jumper is set to FR, the source selection will always be made with the front panel control whatever is connected at the rear panel or the setting of the **MUSIC CONTROL** switch. If external control of music level only (i.e., not source selection) is required, J6 (Zone 1) and/or J7 (Zone 2) should be set to FR and the **MUSIC CONTROL** switch to REMOTE.

See page 4 for location of internal jumpers.

Note that independent remote control of music level or source selection in areas fed by the Utility output is not possible. However, the Utility Output can be "slaved" to Zone 1's source selection and level; the Utility output will then follow any remote control in Zone 1. See page 17 for more details.

Microphone input

Phantom power

The **MICROPHONE INPUT** has 15 V phantom power available. This will be adequate to power a wide range of condenser microphones. (Some “studio quality” mics may require a higher phantom voltage and thus necessitate an external PSU.) To enable phantom power at the mic input, internal motherboard jumper J1 should be moved to its ON position. See page 4 for jumper location.

Phantom power should NOT be enabled if dynamic microphones are to be used.

Gain & level

The **MICROPHONE INPUT** is provided with a rear panel preset **GAIN** control ([4] on page 11). A wide range of gain is available and there should be no problem in obtaining a satisfactory level from any normal microphone.

The **GAIN** control should be adjusted by speaking normally into a microphone of the correct type. Turn the front panel Mic Level control up to maximum and listen in a convenient zone; the rear panel gain control should be carefully advanced until the mic volume is as loud as it is ever likely to be needed, and then reduced slightly. There should be no audible distortion. The use to which the microphone is to be put should be borne in mind – karaoke is more likely to overload the mic preamplifier than spoken announcements, if the gain is not set correctly.

In normal operation, the mic level in each primary zone is set with the Mic Level controls on the front panel ([3] on page 10). The mic level at the Utility output is set with the rear panel preset control ([9] on page 11).

EQ

The mic input has associated HF and LF EQ controls ([5] on page 11) These provide 10 dB of cut or boost at 5 kHz and 100 Hz respectively and should be adjusted by listening to achieve a clear mic sound. Again, the application should be borne in mind when making adjustments.

High-pass filter

The mic input has a fixed 100 Hz high-pass filter to remove the lowest frequencies. This helps to reduce the effects of breath blasts and microphone handling noise. The filter is always in circuit.

Zone and Utility outputs

In normal operation, the music level in each primary zone will be set by the front panel **MUSIC LEVEL** control, or by a corresponding control on a remote plate. The music level at the Utility output will be set by the rear panel **UTILITY MUSIC** preset control.

EQ

The various zones in a building often have different acoustic properties, and may also have different models of loudspeaker installed. The 36-50 is fitted with HF and LF EQ adjustments ([8] on page 11) for the music signal of each primary zone output to enable the audio frequency response to be best matched to each zone. The controls should be adjusted by listening; up to 10 dB of cut or boost at 10 kHz (HF) and 50 Hz (LF) is available. Note that these EQ adjustments do not affect the frequency response of the microphone signal.

Utility output settings

The “third” channel of the 36-50 can be used for various purposes: a common application is to drive loudspeakers in secondary areas such as corridors, lobbies or toilets, where there is no necessity to make frequent alterations to the music source or level.

Alternatively, it can be used to effectively double the power available from Zone 1’s amplifier, by “slaving” its power amplifier section to that of Zone 1. The Utility output then becomes an additional power amplifier “paralleled” to Zone 1.

Three configuration options are available for the Utility output, selectable by internal jumpers J10. These are:

- The Utility output is always fed with the music signal connected to **LINE 1**.
- The Utility output always follows the music source selection made for Zone 1 (either on the front panel or via a remote control plate). The **MUSIC LEVEL** control for Zone 1 does not affect the level at the Utility output, which continues to be determined by the setting of the rear panel **UTILITY MUSIC** preset control. This is the factory default setting.
- The Utility output is fed with Zone 1’s signal, post its **MUSIC LEVEL** control, thus becoming a “slave” of Zone 1. The front panel **MUSIC LEVEL**, **MUSIC SOURCE** and **MIC LEVEL** controls will all affect the signal at the Utility output, and the rear panel **UTILITY MIC** and **MUSIC** preset controls are inoperative.

See page 4 for locations and settings of PCB jumpers.

High-pass filters

When the 36-50 is used to drive 70 V/100 V-line loudspeaker systems, either via an internal CXL-3120 module (as in the 36-50T) or via external CXL-40T transformers, there is a risk of transformer saturation at high levels and low frequencies. To prevent this, each of the 36-50’s three channels (two primary zones and the Utility output) are provided with a switchable 65 Hz high-pass filter. These should be enabled for any channels being used to drive 70 V/100 V-line systems.

The filters are enabled by moving internal PCB jumpers J5 (Zone 1), J8 (Zone 2) and J9 (Utility output). See page 4 for locations of PCB jumpers.

In the Model 36-50T, the jumpers are set with the filters enabled at the factory for all channels.

Priorities

The 36-50 offers several options for determining what happens to music signals when announcements are made.

Mic-over-Music priority

Fully automatic, voice operated priority is available for the mic input. This is selected by the rear panel **PRIORITY** button, which should be IN to enable priority operation. When enabled, all music signals will attenuate by approximately 30 dB when the microphone is used; after the announcement, the music signals will restore smoothly to their former level, over a period of 3, 6 or 12 seconds.

The “release” time may be set 3 s or 6 s by moving J11, or to 12 s by removing J11 altogether. Note that the release time setting will apply to all music ducking, regardless of whether initiated by the mic input or Line 6 priority (see below).

See page 4 for location of the internal jumpers.

Line 6 priority

It may sometimes be necessary for one music input to have priority over all the others; for example, a jukebox in a bar, or a digital sound store programmed to make automatic announcements in a public space. Input **LINE 6** may be set to have priority in either or both primary zones over whichever source is selected for the zone by its **MUSIC SOURCE** control. This priority is set by moving internal jumper J12 (Zone 1) or J13 (Zone 2) to the ‘ON’ position. (The default setting is ‘OFF’.)

When the priority is selected, a signal present at Line 6 will force the zone’s source selection to that input; when the signal disappears, the previously-selected source will be restored over the time constant selected by J11.

See page 4 for location of the internal jumpers.

OPTIONS AND ADDITIONAL INFORMATION

RL-1 and RSL-6 Series remote control plates – general considerations

Cloud RL-1 Series and RSL-6 Series remote control plates are available in three form factors, two fit single-gang UK or American electrical back boxes respectively; the third is a 50 x 50 mm “Media” module, suitable for “Euro-module” mounting frames available in most European countries. Back boxes of either the recessed type or surface-mounting type may be used, providing they are at least 25 mm deep.

The plates should be connected to the **REMOTE SOURCE+LEVEL** port of the relevant zone using single- or twin-core screened cable as described at page 14 and page 15. The plate terminations are conventional screw terminals and the **REMOTE SOURCE+LEVEL** port on the mixer is a 3-pin 5 mm-pitch screw terminal connector.

The remote control plates are passive and thus do not draw any current from the mixer.

Control of music source and level via external DC

It may be necessary in some installations to adjust the music level and select music source in one or more zones from an external control system (e.g., Crestron, AMX, etc.). If the **REMOTE SOURCE+LEVEL** ports are not required for RL-1/RSL-6 Series remote control plates, they may be used to receive DC voltages from the external system to effect these adjustments.

Both music source selection and level can be controlled over their full ranges with a DC voltage of 0 to +10V. The pinout of the **REMOTE SOURCE+LEVEL** port is as follows:

PIN	USE
1	0V ref.
2	Music level control (0 to +10V)
3	Music source selection (0 to +10V)

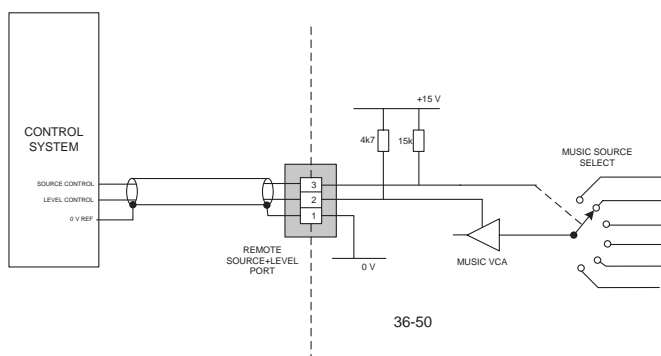

NOTE: If the control voltage source is not isolated from the

power earth, there is a small risk of creating a ‘ground loop’ by linking the mixer technical ground (0V) to the ground (0V) of the equipment supplying the control voltages. To minimise this risk, we suggest that all pieces of equipment be in close proximity, and supplied from the same power outlet.

Music level

Music level in a zone may be varied over its full range by applying a DC voltage of between 0V and +10V to pin 2, the 0V reference being connected to Pin 1. 0V on pin 2 corresponds to maximum level and +10V will produce 60 dB of attenuation. The rate of attenuation is approximately 165 mV/dB.

Note that there is an internal 4k7 “pull-up” resistor between pin 2 and the internal +15V rail. If pin 2 is left “floating”, this pull-up will result in full attenuation. The output impedance of the control voltage source should be low enough to overcome the effect of this resistor.

Music source

Music source for a zone may be controlled by applying various DC voltages of between 0 and +10V to pin 3, the 0V reference being connected to pin 1. 0V at pin 3 will select Line input 6 and between +7.5 and +9V will select Line input 1. The other line inputs will be selected with intermediate voltages. Taking pin 3 above +9V will deselect all inputs, making the zone effectively ‘off’ for music.

The table below lists the DC voltages required at pin 3 to select each line input. The third column is the value of a resistor which should be connected between pins 1 and 3 to permanently ‘force’ a zone to a particular line input.

INPUT	DC VOLTAGE	RESISTOR VALUE
OFF	>+9.0V	
Line 1	+7.5V	16k
Line 2	+6.0V	11k
Line 3	+4.5V	6k8
Line 4	+3.0V	3k9
Line 5	+1.5V	1k8
Line 6	0V	short-circuit

Note that there is an internal 15k “pull-up” resistor between pin 3 and the internal +15V rail. If pin 3 is left “floating”, this pull-up will cause ‘OFF’ to be selected. The output impedance of the control voltage source should be low enough to overcome the effect of this resistor.

Fitting loudspeaker EQ cards

The 36-50 is compatible with various popular installed-sound loudspeakers; a single-channel loudspeaker equalisation module may be fitted to any or all of the three outputs as required, to optimise the frequency response of the channel to the loudspeaker type being used.

The cards may be obtained from Cloud Electronics as optional accessories. Please check the Cloud website (www.cloud.co.uk) for makes and models of loudspeakers for which compatible EQ cards are available. For the 36-50, an adaptor (Cloud Part No. CA963EQA) is also required for each channel; these will be supplied with the EQ cards.

To install equalisation modules, first disconnect the 36-50 from the AC mains supply, then remove the top cover from the 36-50 (8 screws). The modules plug into the 10-pin headers labelled CON2 (Zone 1), CON3 (Zone 2) and CON4 (Utility output) on the main PCB. Proceed as follows:

1. For each of the channel(s) having the EQ cards fitted, remove the factory jumper fitted to the right-hand pair of pins (as viewed from the rear).
2. For the same channel(s), enable the 65 Hz high-pass filter by moving jumpers J5 (Zone 1), J8 (Zone 2) and/or J9 (Utility output) to their ON position.
3. Remove the M3 screws (identified with white arrows) adjacent to the three 10-pin headers; retain it.
4. Fit the M3 hex spacer supplied with the EQ card in place of the screw.
5. Plug the 12-pin to 10-pin adaptor supplied with the EQ card onto the 10-pin PCB header, ensuring that the hole in the card aligns with the hex spacer.
6. Use the screw from step 3 to secure the adaptor to the spacer
7. Plug the EQ card into the 12-pin socket on the adaptor;
8. Replace the top panel.

See the Appendix section “PCB jumper locations and settings” page 4 for further details. Replace the top cover with the original screws after fitting.

Fitting the CXL-3120 transformer module

NOTE: Full installation instructions are included with the transformer module.
The notes below are an abridged version.

The CXL-3120 transformer allows the 36-50 to be used with 100V/70V-line loudspeaker systems.

1. Disconnect the 36-50 from the mains and remove the top cover.
2. Remove the blanking plate from the **SPEAKER LINE OUTPUTS** connector location on the rear panel; retain the plate and screws, nuts and washers.
3. The CXL-3120 is preset for 100V-line operation. If 70V operation is needed, change the solder links on the rear of the CXL-3120 PCB.
4. Fit the module to the right-hand side of the 36-50 (viewed from the rear) by the six hex spacers, using the screws supplied.
5. Connect the 2-pin headers on the CXL-3120 PCB to the corresponding headers on the 36-50 main PCB (immediately behind the lo-Z output connector) using the jumper cables supplied. Note that any or all of the three channels may be converted as required.
6. Enable the 65 Hz high-pass filters for the relevant channels (J5, J8 & J9). See page 4 for jumper locations.
7. Fit the two hex spacers supplied to the holes vacated in Step 2 using the same screws, nuts and washers.
8. Replace the cover.
9. After connecting the 100V/70V-line loudspeaker system using the supplied mating connector (see page 15), fit the blanking plate from Step 2 onto the hex spacers (Step 6) over the connector, with the printed warnings outwards.

APPENDIX

Table of internal jumpers and default settings

The 36-50 has various internal jumpers, the setting of which may require alteration during installation. All the jumpers are on the main PCB. The table below lists each jumper and its purpose, together with the factory default setting.

JUMPER	NAME	EFFECT	DEFAULT
J1	Mic phantom power	OFF: MIC 1 phantom power OFF ON: MIC 1 phantom power ON	OFF
J2	Bypass mic access port for Zone 1	PRESENT: Mic has permanent access to Z1 ABSENT: Use access port to enable access to Z1	PRESENT
J3	Bypass mic access port for Zone 2	PRESENT: Mic has permanent access to Z2 ABSENT: Use access port to enable access to Z2	PRESENT
J4	Bypass mic access port for Utility output	PRESENT: Mic has permanent access to Utility output ABSENT: Use access port to enable access to Utility output	PRESENT
J5	Zone 1 65 Hz high-pass filter	OFF: full frequency response ON: 65 Hz hi-pass filter enabled for Zone 1	OFF
J6	Music source selection – Zone 1	SW: Source follows rear panel MUSIC CONTROL switch FR: Always via front panel only (Z1)	SW
J7	Music source selection – Zone 2	SW: Source follows rear panel MUSIC CONTROL switch FR: Always via front panel only (Z1)	SW
J8	Zone 2 65 Hz high-pass filter	OFF: full frequency response ON: 65 Hz hi-pass filter enabled for Zone 2	OFF
J9	Utility output 65 Hz high-pass filter	OFF: full frequency response ON: 65 Hz hi-pass filter enabled for Utility output	OFF
J10*	Utility output source select	LINE 1: Utility output always uses Line 1 as source ZONE 1: Utility output follows Zone 1 source selection SLAVE: Utility output follows Zone source and level	ZONE 1
J11	Music ducking release time	3S: 3 seconds release time 6S: 6 seconds release time ABSENT: 12 seconds release time	3S
J12*	Line 6 priority – Zone 1	OFF: No priority ON: Line 6 has VOX-triggered priority over other sources in Zone 1	OFF
J13*	Line 6 priority – Zone 2	OFF: No priority ON: Line 6 has VOX-triggered priority over other sources in Zone 2	OFF

*NOTE: J10, J12 & J13 each consist of two sets of jumpers

PCB jumper locations

The diagram below shows the locations of the internal jumpers (not to scale) on the main PCB. The jumpers have two possible positions; the black square in the symbol indicates the default setting. If any jumpers need to be changed, turn the Mixer Amplifier off and disconnect it from the mains. Undo the 8 screws securing the top cover of the unit and remove it. Use a pair of small pliers to gently remove the jumpers from the PCB headers and reposition them. Refit the top cover using the original screws.

The diagram also shows the locations of the socket for the optional loudspeaker EQ cards (CON2, CON3 & CON4).

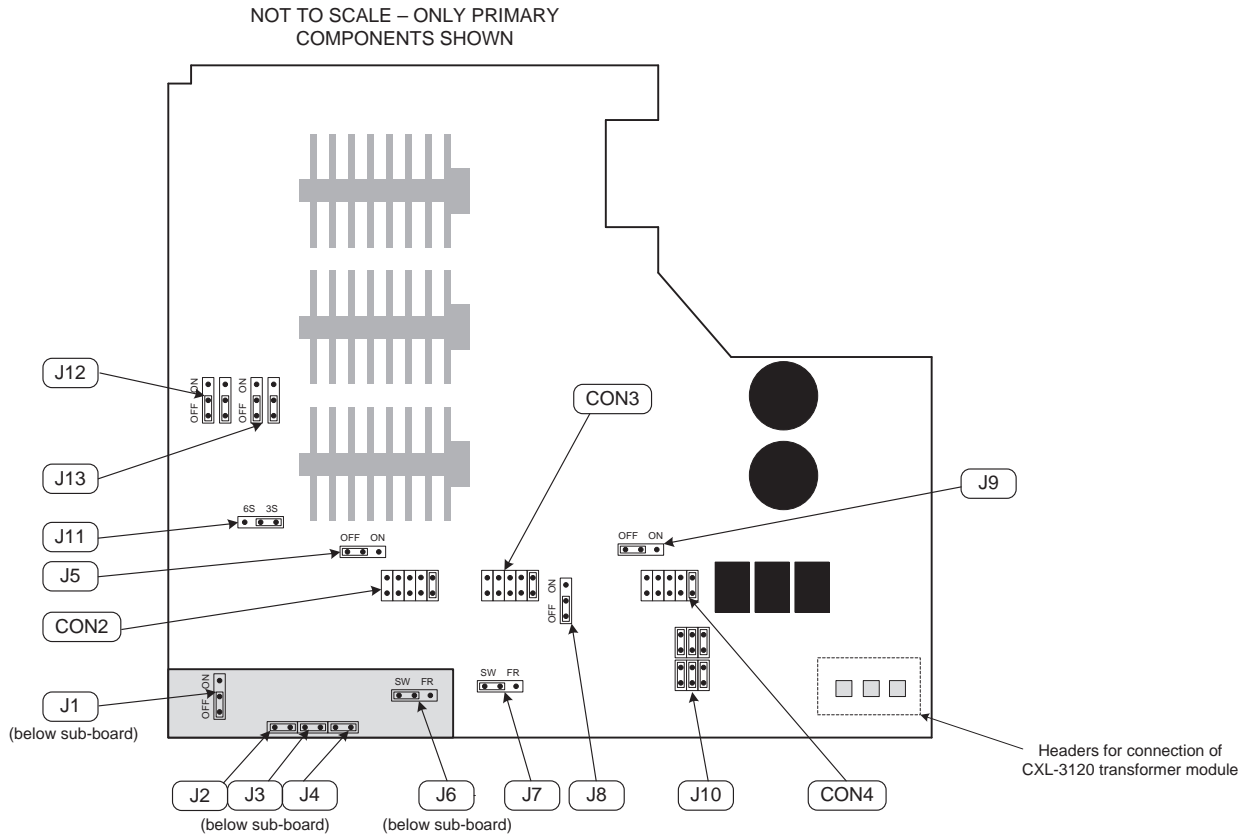

EMC considerations

The Cloud 36-50 fully conforms to the relevant electromagnetic compatibility (EMC) standards and is technically well behaved; you should experience no operational problems and under normal circumstances, no special precautions need to be taken. If the unit is to be used within close proximity to potential sources of HF disturbance such as high power communications transmitters, radar stations and the like, the performance of the mixer may be reduced; we suggest that the microphone cable screen be connected to the shell of the XLR type connector and the line input leads are kept as short as possible.

Ground loops

If, despite your best efforts, the completed sound system ‘hums’ you probably have a ‘ground loop’. The offending signal source can often be identified by setting the volume control to minimum, then disconnecting the input leads (both left & right channels) on each line input until the ‘hum’ disappears. This problem is often caused by terminating a screened input cable into a signal source positioned a significant distance from the mixer. A good way of avoiding this potential problem is to use signal sources (typically ‘consumer’ equipment) that are double insulated with no connection to the mains supply earth. If a signal feed were derived from a second mixer (a club or microphone mixer for example) it would be perfectly normal to expect this to be earthed; we suggest that a transformer be used to isolate the signal and prevent a noisy loop (see page 12).

TECHNICAL SPECIFICATIONS

Line Inputs			
Frequency Response	20 Hz to 20 kHz ± 0.5 dB		
Distortion	<0.05%, 20 Hz to 20 kHz		
Sensitivity	195 mV (-12 dBu) to 2.0V (+8 dBu)		
Input gain control range	20 dB		
Input Impedance	47 kohms		
Headroom	>20 dB		
Noise	-90 dB A-weighted (0 dB gain)		
Equalisation	HF: ± 10 dB @ 10 kHz; LF: ± 10 dB @ 50 Hz		
Microphone Inputs			
Frequency Response	100 Hz -3 dB (fixed filter) to 20 kHz ± 0.5 dB		
Distortion	<0.05%, 20 Hz to 20 kHz		
Gain Range	0 dB to 60 dB		
Input Impedance	>2 kohms (balanced)		
Common mode rejection	>70 dB @ 1 kHz		
Headroom	>20 dB		
Noise	-126 dB EIN, 22 Hz to 22 kHz ($R_s = 150$ ohms)		
Equalisation	HF: ± 10 dB @ 5 kHz; LF: ± 10 dB @ 100 Hz		
Outputs			
Low Impedance Outputs	4 ohm load(s)	1 ch driven	60 W
		2chs driven	52 W
		3chs driven	45 W
	8 ohm load(s)	1 ch driven	37 W
		2chs driven	34 W
		3chs driven	30 W
100V-line Output*	100V balanced – 250 ohm min. load		
70V-line Output*	70V balanced – 125 ohm min. load		
Amplifier protection	VI Limiting, DC Offset, thermal & switch-on delay		
Cooling	Convection		

* with optional CXL-3120 module fitted internally

GENERAL SPECIFICATIONS

Power input	230V $\pm 5\%$ (115V $\pm 5\%$ available)
Fuse rating	230V:T3.15AH; 115V:T6.3AH
Fuse type	20 mm x 5 mm 250V
Dimensions	482.6 mm x 88 mm (2U) x 300 mm deep (not inc. rear connectors)
Weight	6.7 kg net (36-50); 8.9 kg net (36-50T)



Cloud Electronics Limited
140 Staniforth Road
Sheffield S9 3HF
England
Tel: +44 (0)114 244 7051
Fax: +44 (0)114 242 5462
email: info@cloud.co.uk
web: www.cloud.co.uk

Cloud Electronics USA
2065 Sidewinder Drive,
Suite 200, Park City,
Utah 84060.
United States of America.
Toll Free: 0855 810 0161
Web: www.cloudusa.pro
E-mail: sales@cloudusa.pro